

Part Number	Size	Deg	R	O	H	S Min	L
53710	1"	22.5°	18	1.375	6.875	1.875	7.0625
53712	1 1/4"	22.5°	18	1.375	6.875	2	7.0625
53715	1 1/2"	22.5°	18	1.375	6.875	2	7.0625
53720	2"	22.5°	18	1.375	6.875	2	7.0625
53725	2 1/2"	22.5°	18	1.375	6.875	3	7.0625
53730	3"	22.5°	18	1.375	6.875	3.125	7.0625
53735	3 1/2"	22.5°	18	1.375	6.875	3.25	7.0625

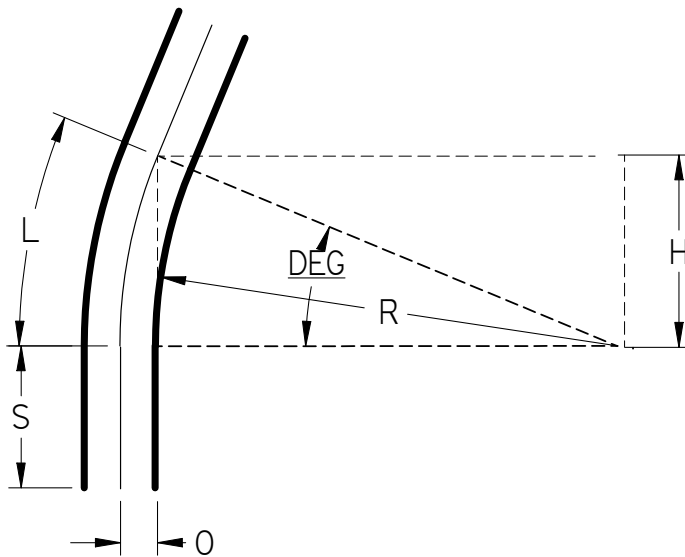

Ⓢ Listed 651
 NEMA TC3
 See NEC Article 352 for Usage

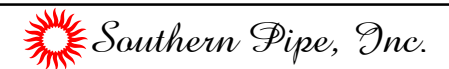

22.5° Elbows Plain End Schedule 80 18" Radius

UNLESS OTHERWISE SPECIFIED
 DIMENSIONS ARE IN INCHES
 ANGLES ±2.0°

	NAME	DATE
DRAWN	K. Mitchell	03/28/13
CHECKED		
ENG APPR		
FILE: 22.5 DEG SCH 80 18 RAD PE.dwg		REV 10