

Part Number	Size	Deg	R	O	H	S Min	L
53810	1"	22.5°	24	1.8125	9.1875	1.875	9.4375
53812	1 1/4"	22.5°	24	1.8125	9.1875	2	9.4375
53815	1 1/2"	22.5°	24	1.8125	9.1875	2	9.4375
53820	2"	22.5°	24	1.8125	9.1875	2	9.4375
53825	2 1/2"	22.5°	24	1.8125	9.1875	3	9.4375
53830	3"	22.5°	24	1.8125	9.1875	3.125	9.4375
53835	3 1/2"	22.5°	24	1.8125	9.1875	3.25	9.4375
53840	4"	22.5°	24	1.8125	9.1875	3.375	9.4375

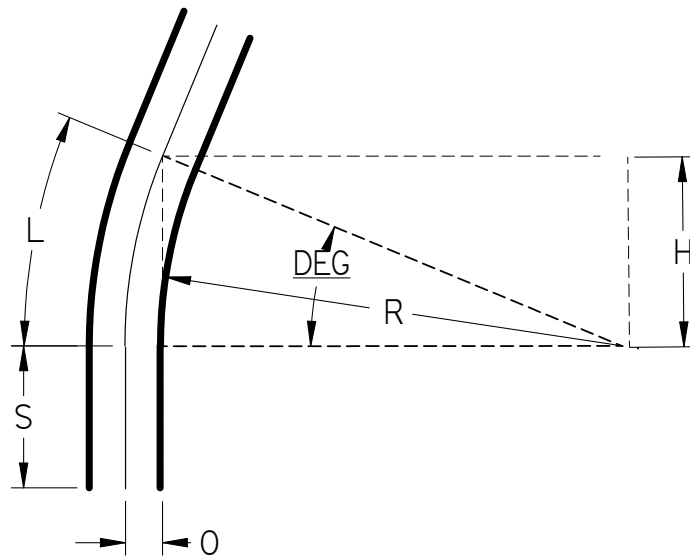

UL Listed 651
 NEMA TC3
 See NEC Article 352 for Usage

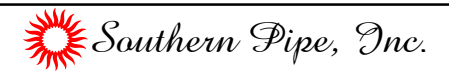

22.5° Elbows Plain End Schedule 80 24" Radius

UNLESS OTHERWISE SPECIFIED
 DIMENSIONS ARE IN INCHES
 ANGLES ±2.0°

	NAME	DATE
DRAWN	K. Mitchell	03/28/13
CHECKED		
ENG APPR		
FILE: 22.5 DEG SCH 80 24 RAD PE.dwg		REV 10