

Part Number	Size	Deg	R	O	H	S Min	L
53910	1"	22.5°	30	2.25	11.5	1.875	11.75
53912	1 1/4"	22.5°	30	2.25	11.5	2	11.75
53915	1 1/2"	22.5°	30	2.25	11.5	2	11.75
53920	2"	22.5°	30	2.25	11.5	2	11.75
53925	2 1/2"	22.5°	30	2.25	11.5	3	11.75
53930	3"	22.5°	30	2.25	11.5	3.125	11.75
53935	3 1/2"	22.5°	30	2.25	11.5	3.25	11.75
53940	4"	22.5°	30	2.25	11.5	3.375	11.75
53950	5"	22.5°	30	2.25	11.5	3.625	11.75

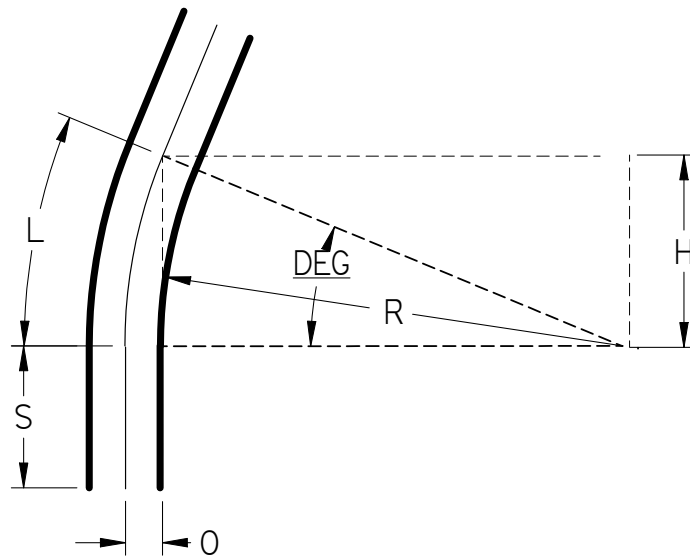

UL Listed 651
 NEMA TC3
 See NEC Article 352 for Usage

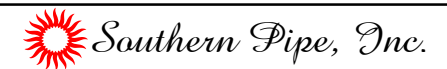

22.5° Elbows Plain End Schedule 80 30" Radius

UNLESS OTHERWISE SPECIFIED
 DIMENSIONS ARE IN INCHES
 ANGLES ±2.0°

	NAME	DATE
DRAWN	K. Mitchell	03/28/13
CHECKED		
ENG APPR		
FILE: 22.5 DEG SCH 80 30 RAD PE.dwg		REV 10