

Part Number	Size	Deg	R	O	H	S Min	L
43220	2"	30°	18	2.4375	9.0625	2	9.4375
43225	2 1/2"	30°	18	2.4375	9.0625	3	9.4375
43230	3"	30°	18	2.4375	9.0625	3.125	9.4375

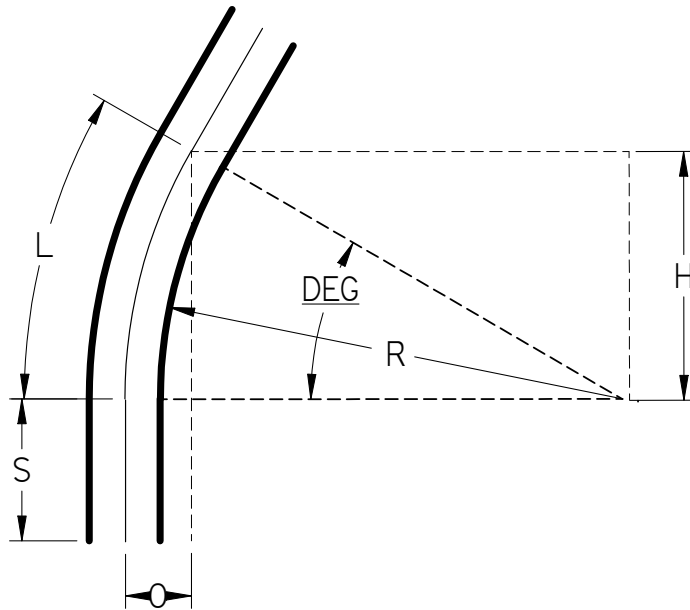

UL Listed 651
 NEMA TC3
 See NEC Article 352 for Usage

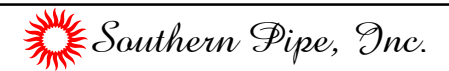

30° Elbows Plain End Schedule 40 18" Radius

UNLESS OTHERWISE SPECIFIED
 DIMENSIONS ARE IN INCHES
 ANGLES ±2.0°

	NAME	DATE
DRAWN	K. Mitchell	03/27/13
CHECKED		
ENG APPR		
FILE: 30 DEG SCH 40 18 RAD PE.dft	REV	10