

Part Number	Size	Deg	R	O	H	S Min	L
53410	1"	30°	30	4	15	1.875	15.6875
53412	1 1/4"	30°	30	4	15	2	15.6875
53415	1 1/2"	30°	30	4	15	2	15.6875
53420	2"	30°	30	4	15	2	15.6875
53425	2 1/2"	30°	30	4	15	3	15.6875
53430	3"	30°	30	4	15	3.125	15.6875
53435	3 1/2"	30°	30	4	15	3.25	15.6875
53440	4"	30°	30	4	15	3.375	15.6875
53450	5"	30°	30	4	15	3.75	15.6875

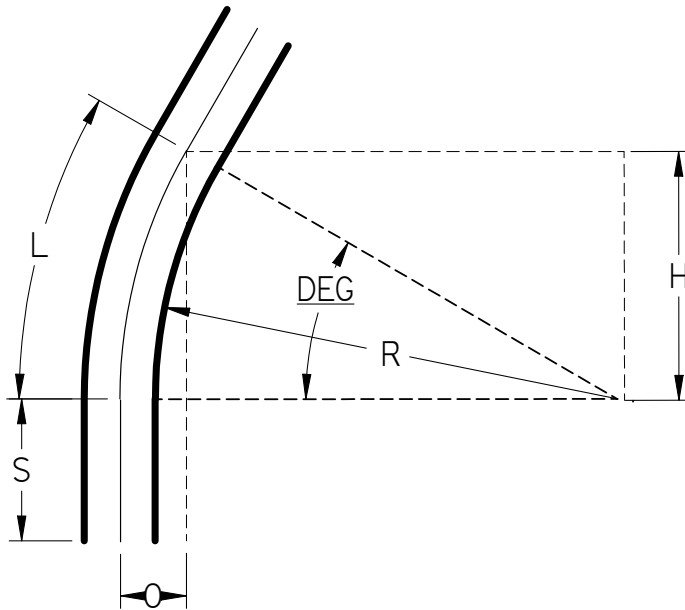

Ⓢ Listed 651
 NEMA TC3
 See NEC Article 352 for Usage



30° Elbows Plain End Schedule 40 30" Radius

UNLESS OTHERWISE SPECIFIED
 DIMENSIONS ARE IN INCHES
 ANGLES ±2.0°

	NAME	DATE
DRAWN	K. Mitchell	03/28/13
CHECKED		
ENG APPR		
FILE: 30 DEG SCH 80 30 RAD PE.dft		REV 10