

Part Number	Size	Deg	R	O	H	S Min	B Min	L
63720	2"	30°	36	4.8125	18	2	1.75	18.875
63730	3"	30°	36	4.8125	18	3.125	2.875	18.875
63740	4"	30°	36	4.8125	18	3.375	3.375	18.875
63750	5"	30°	36	4.8125	18	3.625	4	18.875
63760	6"	30°	36	4.8125	18	3.75	5	18.875

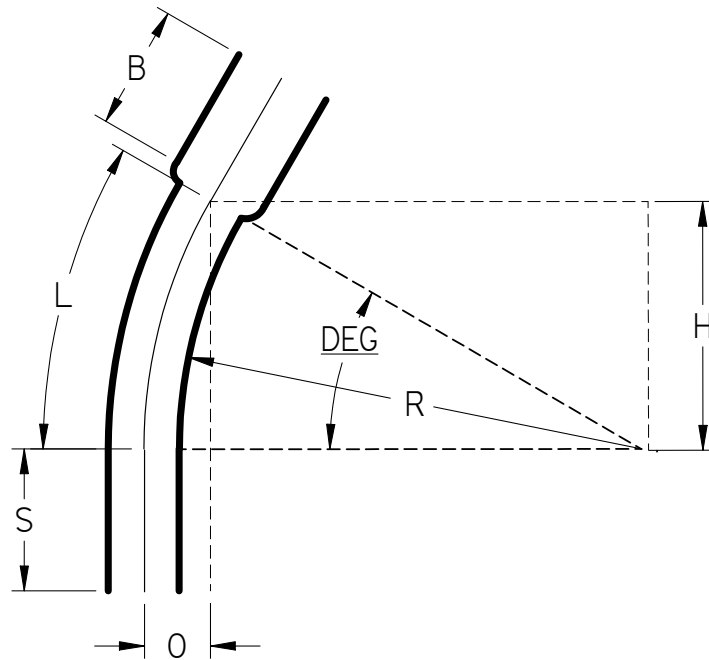

NEMA TC 6
 NEMA TC 3
 See NEC Article 352 for Usage



30° Elbows Belled End TC 6 DB-60 36" Radius

UNLESS OTHERWISE SPECIFIED
 DIMENSIONS ARE IN INCHES
 ANGLES ±2.0°

	NAME	DATE
DRAWN	K. Mitchell	04/01/13
CHECKED		
ENG APPR		
FILE: 30 DEG TC 6 DB-60 36 RAD.dft		REV 10