

Part Number	Size	Deg	R	O	H	S Min	L
52710	1"	45°	18	5.25	12.75	1.875"	14.125
52712	1 1/4"	45°	18	5.25	12.75	2"	14.125
52715	1 1/2"	45°	18	5.25	12.75	2"	14.125
52720	2"	45°	18	5.25	12.75	2"	14.125
52725	2 1/2"	45°	18	5.25	12.75	3"	14.125
52730	3"	45°	18	5.25	12.75	3.125"	14.125

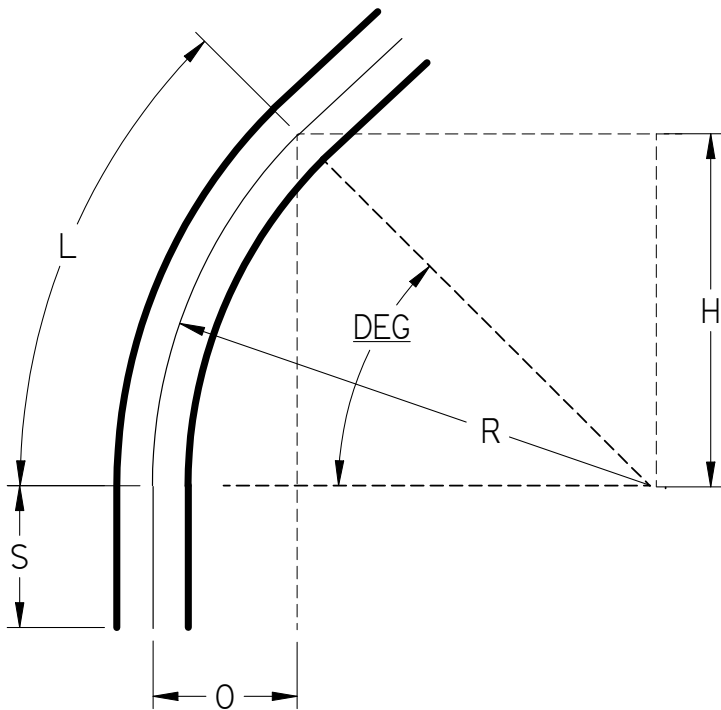

Ⓢ Listed 651
 NEMA TC3
 See NEC Article 352 for Usage



45° Elbows Plain End Schedule 40 18" Radius

UNLESS OTHERWISE SPECIFIED
 DIMENSIONS ARE IN INCHES
 ANGLES ±2.0°

	NAME	DATE
DRAWN	K. Mitchell	03/28/13
CHECKED		
ENG APPR		
FILE: 45 DEG SCH 80 18 RAD PE.dft		REV 10