



Southern Pipe, Inc.

P. O. Box 606, 135 Random Drive, New London, NC 28127

Phone: 704-463-5202 Fax: 704-463-5203 www.southern-pipe.com

PVC Schedule 40 Conduit Fittings

Coupling LISTED

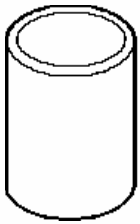

Size	Pkg Qty	Pkg Wt	Part #	Price per 100
½"	200	7.19	40105	\$ 63.19
¾"	125	5.26	40108	77.98
1"	70	4.24	40110	120.11
1 ¼"	40	3.95	40112	160.15
1 ½"	30	3.72	40115	223.49
2"	40	6.79	40120	290.87
2 ½"	20	7.51	40125	512.31
3"	40	21.73	40130	847.29
3 ½"	30	21.35	40135	936.79
4"	20	18.19	40140	1,306.99
5"	10	14.50	40150	3,307.82
6"	8	18.95	40160	4,229.22

Terminal Adapter LISTED

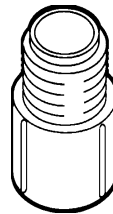

Size	Pkg Qty	Pkg Wt	Part #	Price Per 100
½"	200	6.20	40205	\$ 84.05
¾"	125	5.15	40208	148.75
1"	70	4.39	40210	187.66
1 ¼"	40	3.96	40212	241.36
1 ½"	30	2.95	40215	291.08
2"	40	5.64	40220	418.39
2 ½"	20	5.56	40225	711.32
3"	40	16.09	40230	1,042.15
3 ½"	30	17.66	40235	1,345.24
4"	20	12.73	40240	1,788.76
5"	10	15.31	40250	3,520.58
6"	8	12.54	40260	4,232.11

Female Adapter LISTED

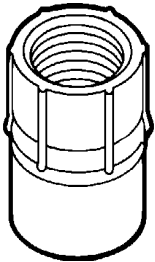

Size	Pkg Qty	Pkg Wt	Part #	Price per 100
½"	200	5.99	40305	\$ 100.38
¾"	125	5.64	40308	158.45
1"	70	4.80	40310	214.24
1 ¼"	40	4.47	40312	286.61
1 ½"	30	3.64	40315	304.79
2"	40	6.75	40320	415.15
2 ½"	20	8.75	40325	921.18
3"	40	19.41	40330	1,149.53
3 ½"	30	20.72	40335	1,504.26
4"	20	17.04	40340	1,541.25
5"	10	14.34	40350	3,833.46
6"	8	16.94	40360	5,060.53



Southern Pipe, Inc.

P. O. Box 606, 135 Random Drive, New London, NC 28127

Phone: 704-463-5202 Fax: 704-463-5203 www.southern-pipe.com

PVC Schedule 40 Conduit Fittings

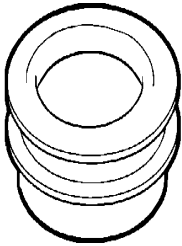

Size	Pkg Qty	Pkg Wt.	Part No	Price per 100
2"	70	5.30	44920	\$329.68
3"	70	9.77	44930	365.46
4"	90	18.55	44940	399.76
5"	45	13.88	44950	494.54
6"	30	9.56	44960	634.51

Long End Bells

Fabricated

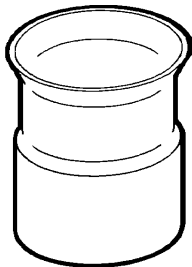

Size	Pkg. Qty	Pkg. Wt	Part No	Price per 100
½"	100		47905	
¾"	100		47908	
1"	50		47910	
1 ¼"	50		47912	
1 ½"	50		47915	
2"	40	11.71	47920	\$1,150.78
2 ½"	30		47925	
3"	50	23.51	47930	1,342.73
3 ½"	50		47935	
4"	50	43.34	47940	1,605.34
5"	25	35.71	47950	2,466.14
6"	15	23.04	47960	2,705.84

End Plugs w/ Pull Eye

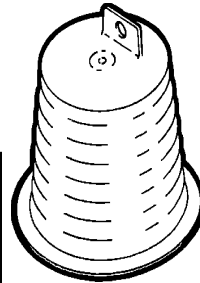

Size	Pkg Qty	Pkg Wt.	Part No	Price per 100
2"	70	5.68	48020	\$329.68
3"	45	6.77	48030	365.46
4"	80	16.66	48040	399.76
5"	45	13.88	48050	494.54
6"	35	10.93	48060	634.51



Southern Pipe, Inc.

P. O. Box 606, 135 Random Drive, New London, NC 28127

Phone: 704-463-5202 Fax: 704-463-5203 www.southern-pipe.com

PVC Schedule 40 Conduit Fittings

End Bells

Molded

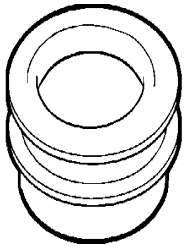

Size	Pkg. Qty	Pkg. Wt	Part No	Price per 100
½"	100	2.25	40405	\$347.16
¾"	100	2.65	40408	385.96
1"	50	2.30	40410	456.42
1 ¼"	50	2.65	40412	557.53
1 ½"	50	4.30	40415	585.20
2"	40	3.60	40420	834.88
2 ½"	30	4.27	40425	904.44
3"	50	8.97	40430	973.35
3 ½"	50	13.42	40435	1,073.33
4"	50	16.37	40440	1,158.21
5"	25	12.62	40450	1,823.69
6"	15	9.36	40460	1,999.69

End Caps

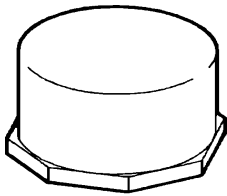

 LISTED

Size	Pkg Qty	Pkg Wt.	Part No	Price per 100
½"	100	2.95	44805	\$ 200.96
¾"	100	5.45	44808	220.68
1"	50	4.00	44810	236.44
1 ¼"	25	2.68	44812	340.87
1 ½"	25	3.68	44815	447.28
2"	50	9.45	44820	616.93
2 ½"	25	8.93	44825	1,345.82
3"	25	13.18	44830	1,405.99
3 ½"	25	17.17	44835	2,147.82
4"	25	22.25	44840	2,929.68
5"	25	26.15	44850	3,400.95
6"	10	18.48	44860	4,654.14

Reducers

 LISTED

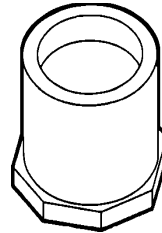

Size	Pkg Qty	Pkg. Wt	Part No	Price per 100
¾" X ½"	100	2.15	40505	\$154.72
1" X ¾"	100	3.35	40508	356.62
1 ¼ X 1"	50	3.40	40510	464.25
1 ½" X 1 ¼"	50	3.35	40512	479.73
2" X 1 ½"	25	3.65	40515	575.92
2 ½" X 2"	25	5.75	40520	1,898.12
3" X 2 ½"	25	9.58	40525	2,286.31
4" X 3"	20	11.08	40530	2,537.73
4" X 3 ½"	20	9.68	40535	2,707.51



Southern Pipe, Inc.

P. O. Box 606, 135 Random Drive, New London, NC 28127

Phone: 704-463-5202 Fax: 704-463-5203 www.southern-pipe.com

Access Fittings

Type LB



LISTED

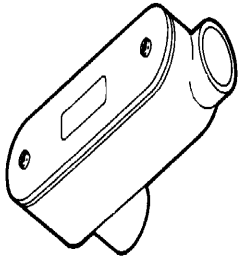

Size	Pkg Qty	Pkg Wt	Part No	Price per 100
½"	25	5.38	45205	\$ 586.26
¾"	15	4.32	45208	752.35
1"	10	3.01	45210	828.22
1 ¼"	10	7.62	45212	1,258.96
1 ½"	10	9.55	45215	1,514.18
2"	5	8.49	45220	2,679.22
2 ½"	5	23.11	45225	9,730.13
3"	5	23.18	45230	10,052.75
3 ½"	4	28.05	45235	10,776.28
4"	4	25.47	45240	11,028.00

Type C



LISTED

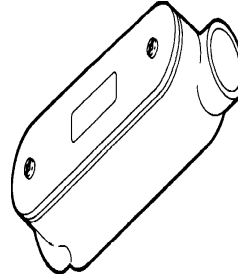

Size	Pkg. Qty	Pkg Wt.	Part No	Price per 100
½"	25	5.18	45605	\$ 608.88
¾"	15	4.23	45608	886.68
1"	10	4.08	45610	963.52
1 ¼"	10	7.35	45612	1,466.04
1 ½"	10	9.39	45615	1,572.41
2"	5	8.04	45620	2,782.26
2 ½"	5	23.12	45625	11,612.56
3"	5	23.52	45630	12,936.28
3 ½"	4	29.37	45635	13,270.14
4"	4	26.45	45640	13,932.00

Type LL



LISTED

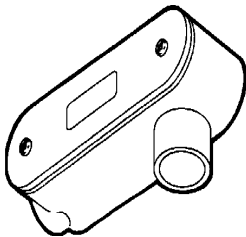

Size	Pkg Qty	Pkg Wt.	Part No	Price per 100
½"	25	5.43	45405	\$ 600.39
¾"	15	4.32	45408	900.47
1"	10	4.21	45410	926.09
1 ¼"	10	7.81	45412	1,339.88
1 ½"	10	9.85	45415	1,572.41
2"	5	8.17	45420	2,730.74
2 ½"	5	25.56	45425	11,612.56
3"	5	19.89	45430	12,938.24
3 ½"	4	29.87	45435	13,270.14
4"	4	20.05	45440	13,932.00

Type LR



LISTED

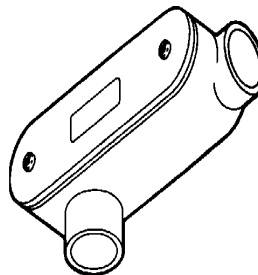

Size	Pkg. Qty	Pkg Wt.	Part No	Price per 100
½"	25	5.43	45305	\$ 589.84
¾"	15	4.36	45308	845.32
1"	10	4.21	45310	914.27
1 ¼"	10	7.72	45312	1,324.13
1 ½"	10	9.64	45315	1,529.07
2"	5	8.18	45320	2,730.74
2 ½"	5	25.56	45325	11,599.00
3"	5	24.18	45330	12,924.65
3 ½"	4	29.87	45335	13,256.53
4"	4	26.45	45340	13,916.45



Southern Pipe, Inc.

P. O. Box 606, 135 Random Drive, New London, NC 28127

Phone: 704-463-5202 Fax: 704-463-5203 www.southern-pipe.com

Access Fittings

Type T

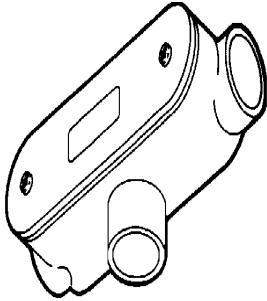

Size	Pkg. Qty	Pkg Wt.	Part No	Price per 100
½"	25	5.18	45505	\$ 756.16
¾"	15	4.27	45508	925.96
1"	10	4.12	45510	965.05
1 ¼"	10	7.62	45512	1,572.41
1 ½"	10	9.80	45515	2,070.93
2"	5	9.17	45520	2,941.52
2 ½"	2	11.25	45525	11,612.56
3"	2	10.41	45530	12,938.24
3 ½"	1	10.20	45535	13,270.14
4"	1	8.98	45540	13,932.00

Type E

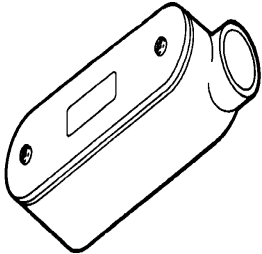

Size	Pkg. Qty	Pkg Wt.	Part No	Price per 100
½"	25	5.08	45705	\$ 612.81
¾"	15	4.09	45708	890.64
1"	10	3.89	45710	1,054.16
1 ¼"	10	7.37	45712	1,316.25
1 ½"	10	9.11	45715	1,572.41
2"	5	8.01	45720	2,782.26
2 ½"	5	21.00	45725	9,828.87
3"	5	19.97	45730	10,121.95
3 ½"	4	23.56	45735	11,529.12
4"	4	27.97	45740	11,942.54



Southern Pipe, Inc.

P. O. Box 606, 135 Random Drive, New London, NC 28127
 Phone: 704-463-5202 Fax: 704-463-5203 www.southern-pipe.com

Access Fitting Dimensions

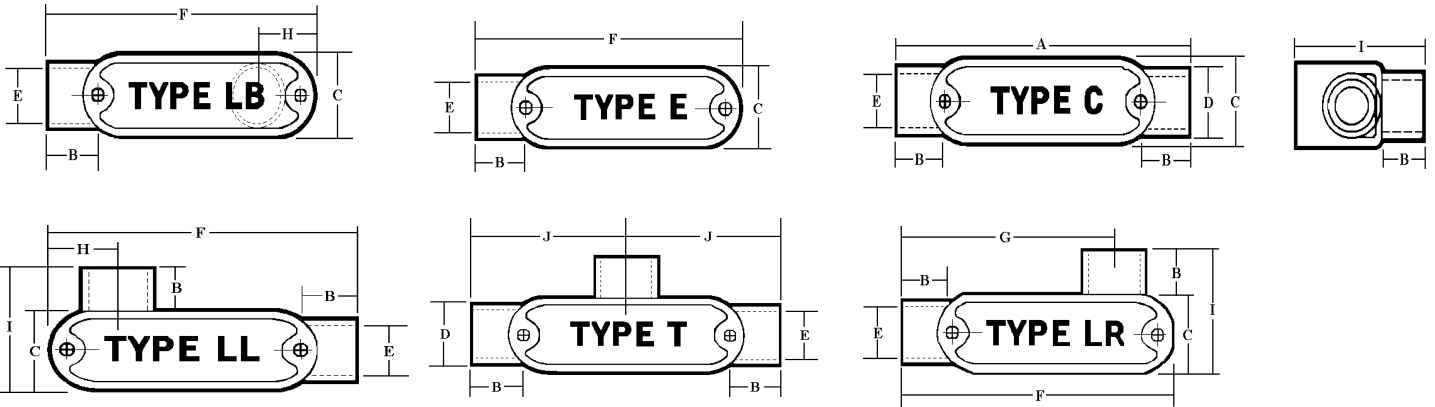

Size	A	B	C	D	E	F	G	H	I	J
½"	5.606	0.639	1.268	1.100	0.840	4.337	4.095	1.297	2.487	2.280
¾"	5.606	0.810	1.536	1.325	1.050	5.395	4.095	1.297	2.487	2.803
1"	6.500	0.910	1.200	1.600	1.335	6.250	4.750	1.500	2.075	3.250
1 ¼"	7.900	1.050	2.300	2.250	1.100	7.625	5.750	1.750	3.575	3.950
1 ½"	8.500	1.125	2.675	2.250	1.900	8.250	6.500	1.750	3.938	4.250
2"	10.875	1.160	3.188	2.820	2.375	10.531	8.156	2.344	4.535	5.438
2 ½"	—	—	—	—	—	—	—	—	—	—
3"	—	1.900	4.500	—	3.510	13.630	10.897	2.733	—	—
3 ½"	—	2.125	5.536	—	4.000	16.000	—	—	—	—
4"	—	2.125	5.536	—	4.530	16.000	—	—	—	—

Notes



Southern Pipe, Inc.

P. O. Box 606, 135 Random Drive, New London, NC 28127
 Phone: 704-463-5202 Fax: 704-463-5203 www.southern-pipe.com

PVC Conduit Outlet Boxes

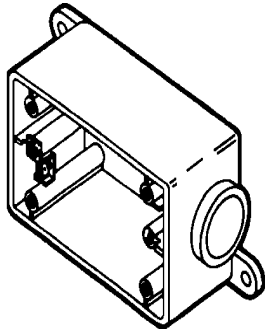

FSE Series

Size	Pkg. Qty	Pkg Wt.	Part No	Price per 100
½"	10	4.27	46105	\$ 1,328.20
¾"	10	4.25	46108	1,395.76
1"	10	4.02	46110	1,564.36

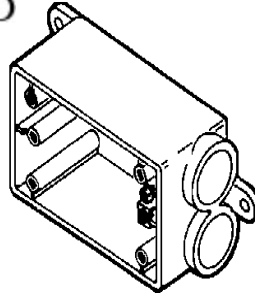

FSS Series

Size	Pkg. Qty	Pkg Wt.	Part No	Price per 100
½"	10	4.53	46305	\$1,422.60
¾"	10	4.26	46308	1,526.32
1"	10	4.02	46310	1,755.62

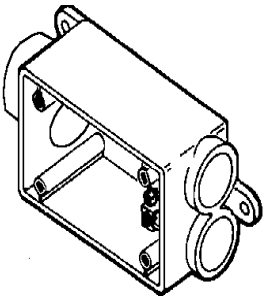

FSCC Series

Size	Pkg. Qty	Pkg Wt.	Part No	Price per 100
½"	10	4.97	46405	\$1,673.93
¾"	10	4.58	46408	1,895.26
1"	10	4.20	46410	2,125.89

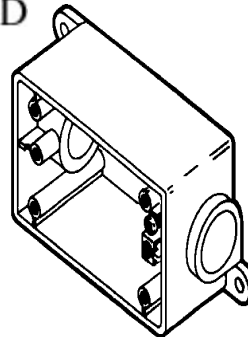

FSC Series

Size	Pkg. Qty	Pkg Wt.	Part No	Price per 100
½"	10	4.75	46205	\$1,395.76
¾"	10	4.50	46208	1,526.32
1"	10	4.21	46210	1,755.62

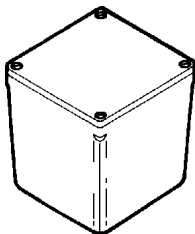

Junction Boxes with Mounting Feet

Size	Pkg Qty	Pkg Wt.	Part No	Price per 100
4 x 4 x 2	10	8.14	45942	\$1,916.22
4 x 4 x 4	10	10.57	45944	3,160.99
4 x 4 x 6	10	11.16	45946	3,644.32
5 x 5 x 2	10	9.24	45952	3,796.15
6 x 6 x 4	10	20.79	45964	3,869.61
6 x 6 x 6	5	11.69	45966	4,515.40
8 x 8 x 4	5	16.46	45984	7,300.62
8 x 8 x 6	4	15.30	45986	8,893.26
8 x 8 x 7	4	20.93	45987	10,919.99
12 x 12 x 4	2	14.93	45914	11,210.56
12 x 12 x 6	2	15.91	45916	11,502.98

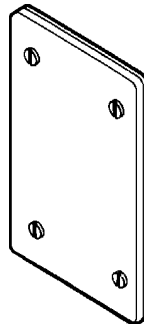

Blank Covers supplied with screws

Size	Pkg. Qty	Pkg Wt.	Part No	Price per 100
—	50	4.40	46000	\$ 719.79



Southern Pipe, Inc.

P. O. Box 606, 135 Random Drive, New London, NC 28127

Phone: 704-463-5202 Fax: 704-463-5203 www.southern-pipe.com

PVC Conduit Fittings

PVC Pipe Straps-2 Hole

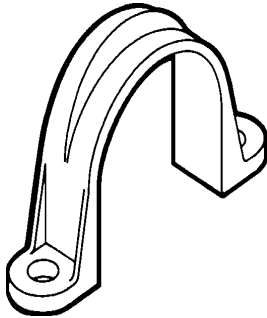

Size	Pkg. Qty	Pkg Wt.	Part No	Price per 100
½"	300	2.05	47405	\$ 46.31
¾"	200	2.45	47408	54.85
1"	200	3.60	47410	67.54
1 ¼"	200	4.60	47412	73.09
1 ½"	200	5.55	47415	85.86
2"	200	7.55	47420	111.76
2 ½"	100	8.35	47425	232.02
3"	100	10.57	47430	416.92
4"	100	12.87	47440	470.47

5° Angle Coupling Sch 40

Bell x Bell

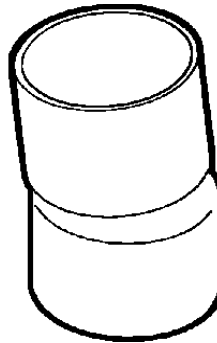

Fabricated

Size	Pkg Qty	Pkg Wt.	Part No	Price per 100
2"	20	4.71	41120	\$2,884.48
3"	25	13.12	41130	3,304.23
4"	15	13.28	41140	3,645.09
5"	8	10.64	41150	4,324.87
6"	4	7.81	41160	6,018.82

Service Entrance Heads

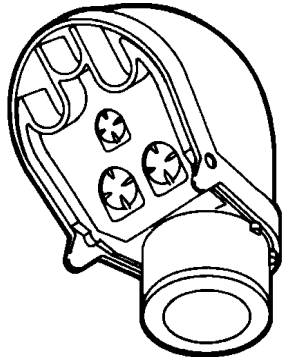

Size	Pkg. Qty	Pkg Wt.	Part No	Price per 100
½"	10	1.10	45005	\$ 814.04
¾"	10	1.40	45008	898.48
1"	20	4.55	45010	1,006.33
1 ¼"	20	8.55	45012	1,353.21
1 ½"	20	10.55	45015	1,634.20
2"	5	5.55	45020	2,721.13
2 ½"	5	25.79	45025	13,820.80
3"	5	22.54	45030	13,362.62
3 ½"	5	21.64	45035	37,533.09
4"	1	15.69	45040	41,116.65

5° Angle Coupling Sch 40

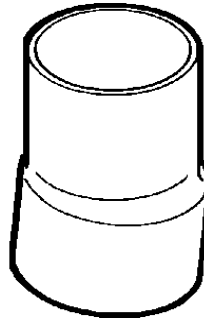

Bell x Plain End

Fabricated

Size	Pkg. Qty	Pkg Wt.	Part No	Price per 100
2"	20	4.71	47720	\$2,172.10
3"	25	13.12	47730	2,478.19
4"	15	13.28	47740	3,189.89
5"	8	11.23	47750	3,573.44
6"	4	8.40	47760	4,539.77



Southern Pipe, Inc.

P. O. Box 606, 135 Random Drive, New London, NC 28127

Phone: 704-463-5202 Fax: 704-463-5203 www.southern-pipe.com

PVC Conduit Fittings

Expansion Coupling-Fabricated

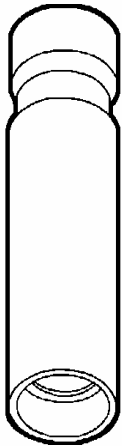

Size	Pkg. Qty	Pkg Wt.	Part No	Price per 100
½"	25	12.68	48505	\$4,151.78
¾"	10	4.75	48508	4,170.78
1"	10	8.03	48510	4,335.84
1 ¼"	5	5.27	48512	4,468.67
1 ½"	5	7.11	48515	4,535.09
2"	25	51.32	48520	4,559.74
2 ½"	12	45.11	48525	6,745.71
3"	12	38.27	48530	8,538.88
4"	6	27.35	48540	12,850.05
5"	1	6.27	48550	19,787.41
6"	1	8.27	48560	27,134.65

Expansion Coupling-Molded

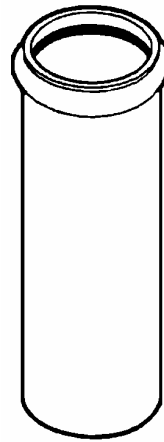

Size	Pkg. Qty	Pkg Wt.	Part No	Price per 100
½"	50	5.20	44705	\$ 2,810.31
¾"	50	8.15	44708	2,767.18
1"	50	12.00	44710	2,902.95
1 ¼"	25	8.70	44712	2,928.08
1 ½"	25	9.20	44715	2,993.79
2"	25	14.60	44720	3,190.44
2 ½"	5	4.35	44725	4,427.33
3"	10	14.13	44730	5,618.06
4"	5	11.12	44740	8,169.64

Meter Offset-Molded

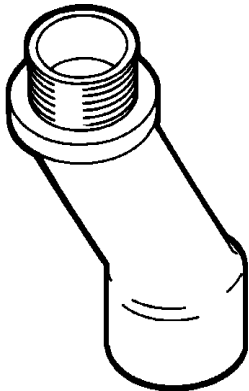

Size	Pkg. Qty	Pkg Wt.	Part No	Price per 100
1 ¼"	15	1.90	47312	\$ 960.59
2"	8	2.08	47320	1,022.85

Also available in fabricated